

# 2024 ANNUAL REPORT







# CONTENTS

<b>ABOUT NEWCASTLE AUSTRALIA INSTITUTE OF HIGHER EDUCATION</b>	<b>4</b>
<b>MESSAGE FROM PVC &amp; CEO</b>	<b>5</b>
<b>BOARD OF DIRECTORS 2024</b>	<b>6</b>
<b>SENIOR MANAGEMENT</b>	<b>8</b>
<b>2024 KEY HIGHLIGHTS &amp; EVENTS</b>	<b>10</b>
<b>ACADEMIC ACHIVEMENTS</b>	<b>13</b>
<b>RESEARCH HIGHLIGHTS</b>	<b>14</b>
<b>ACADEMIC SEMINAR &amp; EVENTS</b>	<b>19</b>
<b>CSD EVENTS</b>	<b>21</b>
<b>STUDENT LIFE</b>	<b>23</b>
<b>ALUMNI EVENTS</b>	<b>26</b>

# ABOUT NEWCASTLE AUSTRALIA INSTITUTE OF HIGHER EDUCATION

We are a wholly-owned entity and the Asia Pacific hub of the University of Newcastle, Australia. We deliver high-quality programs and undertake collaborative research in partnerships with education institutions in Singapore and across the regions.

## UNIVERSITY OF NEWCASTLE'S RANKINGS



**TOP 200**  
OF THE WORLD'S  
UNIVERSITIES

(QS WORLD UNIVERSITY RANKINGS 2025)



**TOP 40**  
IN THE WORLD  
FOR IMPACT

(TIMES HIGHER EDUCATION IMPACT RANKINGS 2024)



**199K+**  
GRADUATES  
WORLDWIDE



**TOP 8**  
IN AUSTRALIA FOR RESEARCH  
'WELL ABOVE WORLD STANDARD'

(EXCELLENCE IN RESEARCH AUSTRALIA, 2018)

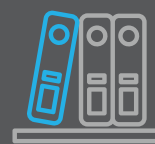

**TOP 200**  
12 SUBJECTS RANKED IN  
THE TOP 200 IN THE WORLD

(QS WORLD UNIVERSITY RANKINGS BY SUBJECT 2024)

# MESSAGE FROM PVC & CEO

2024 has been a defining year for Newcastle Australia, marked by key milestones and a renewed vision for the future. I am honoured to have taken on the role of Pro Vice-Chancellor and CEO in July and to lead our institute into its next chapter of growth and innovation.

I would like to begin by expressing my sincere gratitude to Professor Julia Connell for her exemplary leadership and dedication as Acting PVC & CEO. Her contributions have been instrumental in shaping a strong foundation for our continued growth.

This year has been an exciting and pivotal one for us. We successfully renewed our Enhanced Registration Framework (ERF) status for another four years— a clear endorsement of the strength and compliance of our academic and operational systems. This renewal allows us to move forward with confidence in our long-term strategy and commitment to excellence.

In early 2024, we co-hosted the international conference Leading Sustainability Transitions: Risk, Collaboration, and Technology in partnership with the Academy of Global Business Research and Practice (AGBRP). The event brought together global thought leaders, researchers, and practitioners to exchange ideas on sustainable development and innovation—setting the tone for our own sustainability journey.

Aligned with this focus, we were proud to launch the Centre for Sustainable Development, a new initiative that reflects our deepening commitment to environmental and social responsibility.

On the academic front, we proudly celebrated the first graduating cohorts of the Master of Business Psychology and Master of Special and Inclusive Education. We also introduced our fourth postgraduate program—Master of Environmental Management and Sustainability—expanding our suite of programs to meet the evolving needs of industry and society.

As we look ahead, our focus remains clear: to deliver transformative education and foster sustainable growth. I am excited to embark on this journey with all of you.



**Professor Abhishek Bhati**

Pro Vice-Chancellor and CEO

Newcastle Australia Institute of Higher Education



# BOARD OF DIRECTORS 2024



**PROFESSOR  
KENT ANDERSON**

**Chair of the Board**

Professor Kent Anderson serves as the Deputy Vice-Chancellor (Global Engagement and Partnerships) at the University of Newcastle, Australia, and has since taken on the role of Chair of the Board. Kent has been on a number of boards, including the National Library of Australia Council, Ministerial Council for International Education, Higher Education Standards Panel, New Colombo Plan Advisory Board, Board of Canberra Grammar School and Shenton College (Perth), and President of the Asian Studies Association of Australia and Japanese Studies Association of Australia.



**PROFESSOR  
ABHISHEK SINGH BHATI**

**PVC & CEO, Newcastle Australia IHE**

Professor Abhishek Singh Bhati joined the Newcastle Australia Institute of Higher Education as the Pro Vice-Chancellor and CEO in July 2024. He is recognised as a Fellow of the Higher Education Academy (FHEA) and graduate of Australian Institute of Company Directors (GAICD). He contributes to corporate governance through his Board Directorship of Singapore based enterprises. He serves as a member of the WIL SIG under Australian Collaborative Education Network (ACEN) and is a member of the Academy of Management, USA.



**MR BILL CHUA**

Bill Chua has served on local and foreign boards for the past twenty years. He is currently an Independent Director on the boards of IES-INCA Pte Ltd, United Hampshire US REIT Management Pte Ltd, Sunseap Group Pte Ltd, Citibank Singapore Limited, and BoardRoom Executive Services Pte Ltd, and a Managing Partner and Director of Green Sands Equity Inc. Previously he had served on the boards of Singapore Technologies Electronics Limited, Jurong International, Clearing and Payments Services Pte Ltd, DSO National Laboratories, Defence Science & Technology Agency and Singapore Technologies Kinetics Ltd, and CLS AG.



**MR JASPAL SINGH**

Jaspal Singh started his career with the Singapore Government Administrative Service (1978-2004), serving in the Ministries of Transport, Finance and Trade & Industry and on the Boards of various statutory bodies and Government-linked corporates. This was followed by a 14-year stint in the private sector based in London as CEO, ComfortDelGro (UK & Ireland), where he led the growth of ComfortDelGro's network of bus, coach, taxi, private hire and engineering businesses in England, Wales, Scotland and Ireland.



**DR LEE KWOK CHEONG**

Dr Lee Kwok Cheong, popularly known as KC, retired in 2019 after a 41-year career in IT and education, of which 23 years were in the CEO role. He has been active in shaping Singapore's IT, education, and talents development landscape. Currently, he is on the Board of an education company in Vietnam, an IT services company listed on Singapore Exchange's main Board, a government-owned gaming operator, a music ensemble, and a mental health charity.



**MS YAU SIEW CHOI**

Siew Choi is a seasoned financial services leader with a three-decade long career focused on (re)insurance within the Asia Pacific. Renowned for her innovative strategies and ability to deliver long-term success, she excels in fostering innovation and driving transformative initiatives within tightly regulated landscapes. Armed with a Master's degree from Stanford University and an Executive Diploma in Directorship from Singapore Management University (SMU), she is primed to contribute her extensive Asia-focused financial services acumen to the Newcastle Australia's board.

■ We thank Ms Chia Lee Meng for her contributions to Newcastle Australia until October 2024.

# SENIOR MANAGEMENT



**PROFESSOR  
ABHISHEK SINGH BHATI**  
PVC & CEO

Professor Abhishek Singh Bhati is the Pro Vice-Chancellor and CEO at the Newcastle Australia Institute of Higher Education. Previously, Abhishek held Interim Deputy Vice Chancellor and Campus Dean roles at Universities in Australia and Singapore. He obtained his Doctor of Philosophy (PhD) in Business (Tourism Management) from James Cook University and Master of Business Administration in Marketing Management (MBA) from Maastricht School of Management. In addition, he obtained post-graduate learning and teaching qualifications, Graduate Certificate in Education Tertiary Teaching (GCETT) and Diploma in Adult and Continuing Education (DACE). Abhishek is an active researcher, and his research has been published in a wide variety of reputable publications in the field of tourism and scholarship of learning and teaching.



**A/PROF KOH YIT YAN**  
Acting Academic Director

A/Prof Koh Yit Yan graduated from the University of Leeds, specialising in Engineering Fluid Mechanics. Despite his main research area in Mechanical Engineering, which includes the mathematical modelling of fluid flow with the aid of the supercomputer, he also completed a module on Teaching and Learning in Higher Education, which emphasises pedagogy, learning, and assessment. In addition to his research in the areas of teaching and learning, he has also been invited as speaker and trainer in seminars and workshops related to teaching and learning, sharing best practices in teaching and learning with fellow colleagues and students. Yit Yan is currently also the Honorary Secretary of the South East Asia Association of Institution of Research (SEAAIR) and the Young Member Representative of Institution of Mechanical Engineers (IMechE) Singapore Branch.



**JANE NG**  
Deputy Director, Human Resources and  
Corporate Governance

Jane is currently the Deputy Director, Human Resources and Corporate Governance. She oversees the full of spectrum human resource functions and manages the corporate governance affairs of Newcastle Australia. She holds an honours degree in business administration and certificate in applied psychology. She brings with her more than twenty years of full spectrum human resource experience in both private and public sectors, of which the recent last ten years were in education.



# 2024 KEY HIGHLIGHTS & EVENTS



**JAN 4 LAUNCH OF CENTRE FOR SUSTAINABLE DEVELOPMENT**

The Centre for Sustainable Development (CSD) at Newcastle Australia Institute of Higher Education has been launched as a Centre of Excellence in Singapore and the Asia-Pacific region. Led by Associate Professor Charles Lee, the CSD is dedicated to advancing sustainable solutions in support of the UN Sustainable Development Goals, climate resilience, and food security.



**MAY 4 SAMARITANS OF SINGAPORE'S 55th ANNIVERSARY CHARITY GALA DINNER**

We were proud to sponsor the Samaritans of Singapore's 55th Anniversary Charity Gala Dinner, held on 4 May 2024, with Deputy Prime Minister Lawrence Wong gracing the occasion as the Guest of Honour.



**JUN 25 SICC LUNCHEON**

We were honoured to support the 2024 SICC AGM Luncheon on 25 June, which gathered hundreds of Chamber members and distinguished guests from the business community, government, and the Diplomatic Corps. The event was graced by Mr Chan Chun Sing, Minister for Education.



**JUL 1 WELCOMING NEW PVC & CEO**

We warmly welcomed Professor Abhishek Bhati as the new Pro Vice-Chancellor and CEO of Newcastle Australia, succeeding Professor Julia Connell. Professor Bhati brings extensive experience in transnational education, having previously led James Cook University's Singapore campus.



### JUL 3 STAKEHOLDER MEETING

In July, we hosted a Stakeholder Meeting which brought together partners, MOU partners, board members, alumni, and staff for a meaningful and collaborative gathering. The event warmly welcomed our new PVC & CEO, Professor Abhishek Bhati, and also featured a belated celebration of 22 remarkable years of higher education in Singapore, a proud milestone in our journey.



### AUG 16 STRATEGY DAY

The Newcastle Australia team gathered for a transformative Strategy Day. The day was filled with productive discussions, creative brainstorming, and a clear focus on charting out exciting plans for the future. Amidst all this, we also took a special moment to recognise and celebrate the remarkable milestones achieved by our colleagues.



### AUG 21 CELEBRATING OUR FIRST POSTGRADUATE COHORTS

We celebrated a significant milestone—the achievements of our first postgraduate cohorts. It was a moment to reflect on their inspiring journeys and the paths they've paved for future students.



### SEP 26-27 HONOUR INTERNATIONAL SYMPOSIUM 2024

We were proud to support the Honour International Symposium 2024, held from 26 to 27 September at Pan Pacific Singapore. Centered on the theme "TOTAL SUSTAINABILITY," the symposium brought together like-minded leaders and emerging changemakers from business, government, and community sectors. The event was graced by President Tharman Shanmugaratnam, Patron of Honour (Singapore).



**OCT 11 SILVER AWARD FOR EXCELLENCE IN WORKPLACE WELLBEING**

Newcastle Australia was honoured with the Silver Award in Excellence in Workplace Wellbeing at the prestigious HR Excellence Awards 2024. The HR Excellence Awards celebrate outstanding achievements in human resources and recognise organisations that have made significant strides in enhancing employee experiences.



**OCT 15 LAUNCH OF MASTER OF ENVIRONMENTAL MANAGEMENT AND SUSTAINABILITY**

We proudly launched our fourth postgraduate program in Environmental Management and Sustainability at the "Sustainable Future: Harmonising Business and Environment" event. The program is designed for professionals seeking to lead the charge in addressing the world's most pressing environmental challenges.



**NOV 7 STAKEHOLDER ENGAGEMENT MEETING**

Ahead of a bustling weekend filled with the much-anticipated Alumni Night and Graduation Ceremony in November, we were delighted to welcome the leadership team from the University of Newcastle, Australia. In a vibrant evening session, key stakeholders—including industry partners, collaborators, and other valued contributors—came together with the leadership team for a memorable night of networking and connection.



**NOV 9 GRADUATION 2024**

The University of Newcastle, Australia celebrated a major milestone as we returned to the Star Theatre, honoring the achievements of nearly 220 graduates in a warm and inspiring ceremony. This year's event was especially meaningful, as it marked the first graduating cohorts of the Master of Business Psychology and Master of Special and Inclusive Education programs.



**NOV 22 FAMILY DAY**

Our team enjoyed a fun and refreshing 2D1N "Family Day" retreat in the scenic town of Desaru. It was a great opportunity to unwind, bond, and create lasting memories outside the office.

# ACADEMIC ACHIEVEMENTS

**27**  
PUBLICATIONS IN 2024

**6**  
PUBLICATIONS  
WITH IMPACT FACTOR / CITESCORE >3

**30**  
CONFERENCE PUBLICATIONS

**1**  
PUBLICATION  
WITH IMPACT FACTOR /  
CITESCORE <3

**5**  
INDUSTRY  
ENGAGEMENTS

**>\$200K**  
EXTERNAL RESEARCH FUNDING  
SECURED IN 2024

# RESEARCH HIGHLIGHTS



## LIMB LENGTHENING IMPLANT WITH WIRELESS INTEGRATION

by Chiang Liang Kok, Tat Chin Tan, Yit Yan Koh, Teck Kheng Lee, Jian Ping Chai

This comprehensive study presents a pioneering approach to limb lengthening, leveraging the advancements in wireless technology to enhance orthopedic healthcare. Historically, limb lengthening has been a response to discrepancies caused by fractures, diseases, or congenital defects, utilising the body's innate ability to regenerate bone and surrounding tissues. Traditionally, this involved external or internal fixation devices, such as the Ilizarov and Taylor Spatial frames or the Precice nail and Fitbone. The focal point of this research is the development and testing of a wireless intramedullary nail implant prototype, controlled remotely via a mobile application. This implant comprises a microcontroller, Bluetooth Low Energy module, a brushed DC motor controlled through an H-bridge, and a force sensor, all powered by medical-grade batteries.

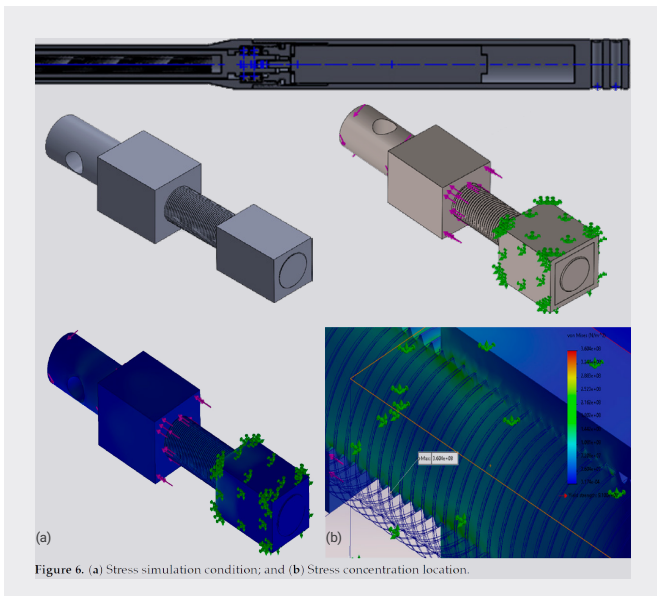
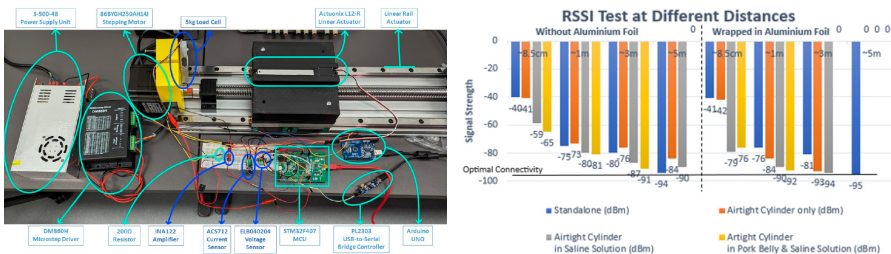
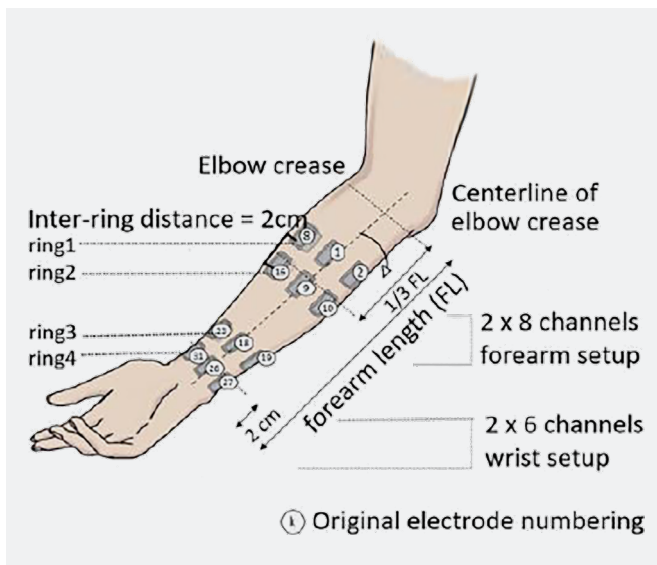

Figure 6. (a) Stress simulation condition; and (b) Stress concentration location.

## OPTIMISING THREAD DESIGN FOR LIMB LENGTHENING IMPLANT

by Chiang Liang Kok, Chee Kit Ho, Hong Wei Ng, Yit Yan Koh, Tee Hui Teo

This comprehensive study presents a pioneering approach to limb lengthening, leveraging the advancements in wireless technology to enhance orthopedic healthcare. The focal point of this research is the development and testing of a wireless intramedullary nail implant prototype, controlled remotely via a mobile application. This implant comprises a microcontroller, Bluetooth Low Energy module, a brushed DC motor controlled through an H-bridge, and a force sensor, all powered by medical-grade batteries.



## MACHINE LEARNING-BASED FEATURE EXTRACTION AND CLASSIFICATION OF EMG SIGNALS FOR INTUITIVE PROSTHETIC CONTROL

by Chiang Liang Kok, Chee Kit Ho, Fu Kai Tan, Yit Yan Koh

Signals play a fundamental role in science, technology, and communication by conveying information through varying patterns, amplitudes, and frequencies. This paper introduces innovative methodologies for processing electromyographic (EMG) signals to develop artificial intelligence systems capable of decoding muscle activity for controlling arm movements. The study investigates advanced signal processing techniques and machine learning classification algorithms using the GRABMyo dataset, aiming to enhance prosthetic control systems and rehabilitation technologies.



## TRANSFER LEARNING AND DEEP NEURAL NETWORKS FOR ROBUST INTERSUBJECT HAND MOVEMENT DETECTION FROM EEG SIGNALS

by Chiang Liang Kok, Chee Kit Ho, Thein Htet Aung, Yit Yan Koh, Tee Hui Teo

In this research, five systems were developed to classify four distinct motor functions—forward hand movement (FW), grasp (GP), release (RL), and reverse hand movement (RV)—from EEG signals, using the WAY-EEG-GAL dataset where participants performed a sequence of hand movements.

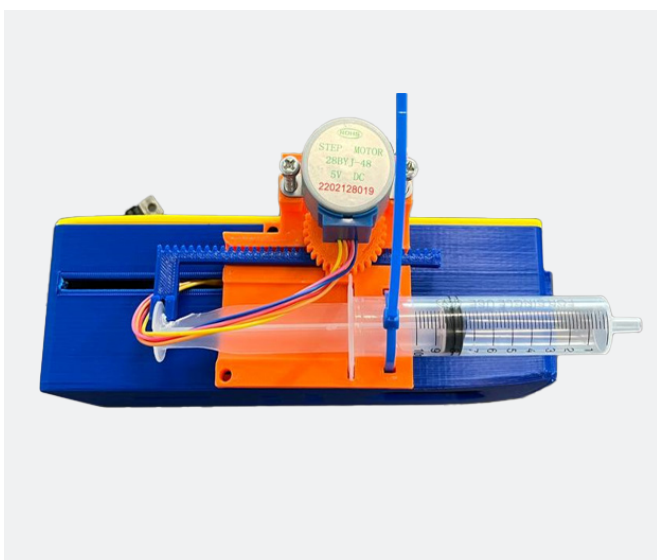

## BIOMEDICAL DRUG INFUSION PORTABLE DEVICE

by Chiang Liang Kok, Yuwei Dai, Teck Kheng Lee, Yit Yan Koh, Tee Hui Teo, Jian Ping Chai

In the present day, IoT technology is widely applied in the field of medical devices to facilitate real-time monitoring and management by medical staff, thereby better-ensuring patient safety. In IoT intravenous infusion monitoring sensors, it is particularly important to ensure that air bubbles are not infused into the patient's body. The most common method for bubble detection during intravenous infusions is the use of infrared or laser sensors, which can usually meet design requirements at a relatively low cost. Another method is the use of ultrasonic detection of bubbles, which achieves high accuracy but has not been widely promoted in the market due to higher costs. This proposed work introduces a new type of sensor that detects bubbles by monitoring changes in capacitance between two electrodes installed at the surface of the infusion pipe.



## SUSTAINABLE CITY FARMING

by Wei Feng Don Chua, Chong Lye Lim, Yit Yan Koh, Chiang Liang Kok

In Singapore's limited land space, hydroponics, a soil-free method of that uses irrigation gained popularity for urban farming. Vertical farming can be made more sustainable by integrating Internet-of-Things (IoT) and solar photovoltaic (PV) as an intelligent system. This study aims to conduct a feasibility study on using PV cells to reduce energy consumption in IoT-enabled irrigation control and monitoring systems.

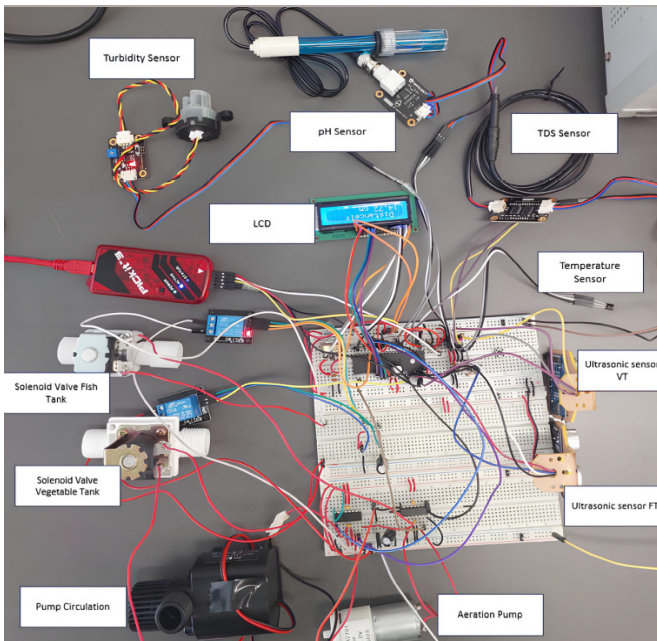

## SMART AQUAPONICS FOR SUSTAINABLE AGRICULTURE

by Chiang Liang Kok, I Made Bagus Pradnya Kusuma, Yit Yan Koh, Howard Tang, Ah Boon Lim

Agricultural technology is evolving, with aquaponic systems emerging as a promising solution to urban food needs. However, these systems present challenges, such as maintaining optimal water quality and minimising environmental control errors. In this study, we propose a comprehensive approach combining a literature review and controlled experiments. Through the literature review, the recent findings on water management and sustainability in food production were analysed, providing crucial insights for enhancing aquaponic system performance.

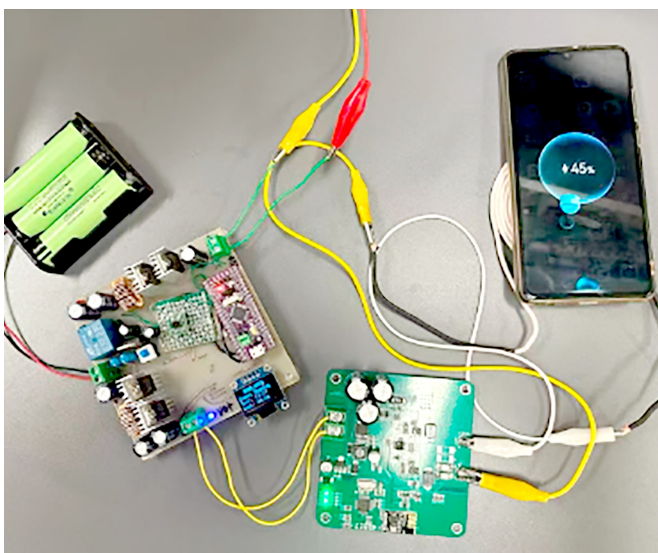

## GREEN ENERGY HARVESTING FOR CHARGING SMARTPHONE

by Chiang Liang Kok, Xuanyao Fu, Yit Yan Koh, Tee Hui Teo

This paper presents the development of a portable solar panel wireless charging device with an advanced charging algorithm. The device features a 6500 mAh Li-ion battery and is designed to efficiently charge smartphones and laptops. It incorporates a simulated solar panel, charging circuit, microcontroller, and wireless charging circuits. Rigorous testing has demonstrated its stable output voltage and current at 5 V/2 A, with high power transfer efficiency.

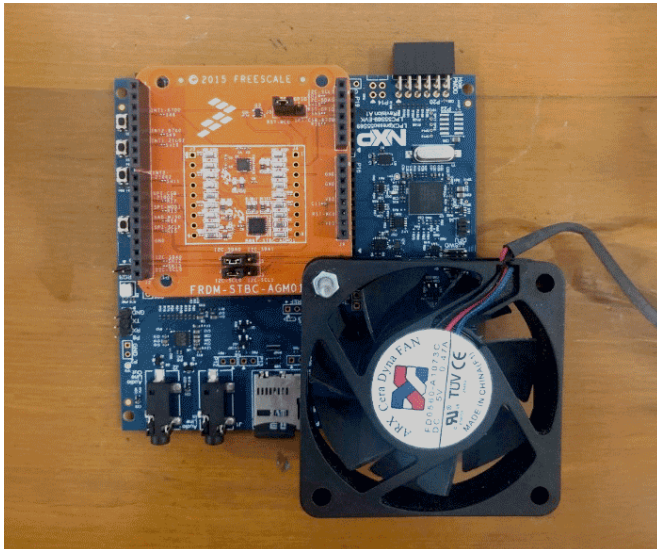

## AN EMBEDDED MACHINE LEARNING FAULT DETECTION SYSTEM

by Khin Htet Htet Aung, Chiang Liang Kok, Yit Yan Koh, Tee Hui Teo

Industrial fans are critical components in industrial production, where unexpected damage of important fans can cause serious disruptions and economic costs. This research developed a methodology for early fault detection in a fan system utilising machine learning techniques to monitor the operational states of the fan. The proposed system monitors the vibration of the fan using an accelerometer and utilises a machine learning model to assess anomalies.



## IMPLEMENTATION OF A SOCIAL ROBOT FOR SUSTAINABLE HUMAN ENGAGEMENT IN HOMECARE SERVICES FOR AGEING POPULATIONS

by Chiang Liang Kok, Chee Kit Ho, Tee Hui Teo, Kenichi Kato, Yit Yan Koh

This research addresses the rapid aging phenomenon prevalent in Asian societies, which has led to a significant increase in elderly individuals relocating to nursing homes due to health-related issues. This trend has resulted in social isolation and loneliness among the elderly, contributing to physical and mental ailments such as hypertension and cardiovascular diseases, as highlighted by the World Health Organisation (WHO). To mitigate these issues, the research proposes leveraging technology, specifically the integration of robotics, to alleviate the caregiver shortage and enhance human interaction for the elderly.



## INNOVATIVE EMD-BASED TECHNIQUE FOR PREVENTING COFFEE GRINDER DAMAGE FROM STONES WITH FPGA IMPLEMENTATION

by Chiang Liang Kok, Yuwei Dai, Yit Yan Koh, Maoyang Xiang, Tee Hui Teo

Coffee is one of the most widely consumed beverages globally, with Americans averaging 3.1 cups per day. However, before coffee beans can be brewed into a drinkable form, they undergo several critical stages, including harvesting, processing, roasting, grinding, and extraction. During the processing and roasting phases, a significant challenge arises: stones that are similar in size and shape to coffee beans can inadvertently mix into the batch. These stones are difficult to detect using conventional methods, and their presence can have severe consequences. When stones are ground alongside coffee beans, they can cause significant damage to the grinder's burrs. To address this issue, this paper proposes a novel method based on Empirical Mode Decomposition (EMD) for detecting stones in coffee beans. The approach analyses the acoustic wave patterns generated when stones impact or rotate within the grinder.

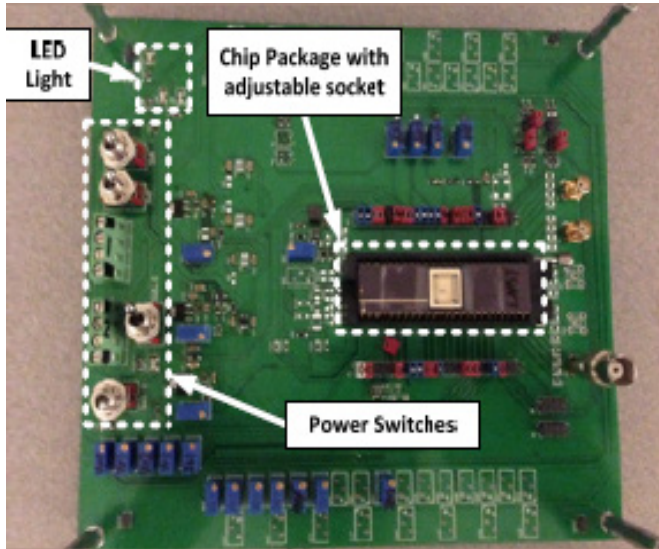

### CONVERTER FOR SMARTPHONE APPLICATION

by Chiang Liang Kok, Liter Siek

In this paper, a buck DC-DC converter with the proposed twin frequency control scheme (TFCS) and accurate load current sensing (ALCS) was designed and implemented with 0.18  $\mu\text{m}$  CMOS technology for a supply voltage ranging from 2.0 to 3.0 V, which is compatible with state-of-the-art batteries (NiCd/NiMH: 1.1–2 V, Li-Ion: 2.5–4.2 V). The proposed converter yields a peak efficiency of about 92.7% with a load current of 30 mA. Furthermore, it only occupies a silicon area of 1.3 mm<sup>2</sup>. The proposed buck converter is dedicated for smartphone applications whereby it spends most of its time in idle, low load conditions.

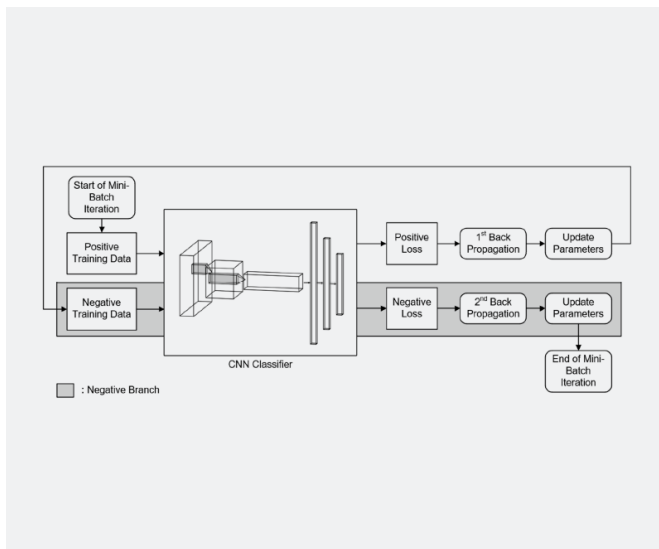

### INTELLIGENT SPEECH RECOGNITION USING AI

by Jiaqi Chen, Tee Hui Teo, Chiang Liang Kok, Yit Yan Koh

Advancements in AI have elevated speech recognition, with convolutional neural networks (CNNs) proving effective in processing spectrogram-transformed speech signals. Artificial neural networks excel in predicting inputs within their expected output range but struggle with anomalies. This is usually harmful to a speech recognition system. In this paper, the neural network classifier for speech recognition is trained with a “negative branch” method, incorporating directional regularisation with out-of-distribution training data, allowing it to maintain a high confidence score to the input within distribution while expressing a low confidence score to the anomaly input.

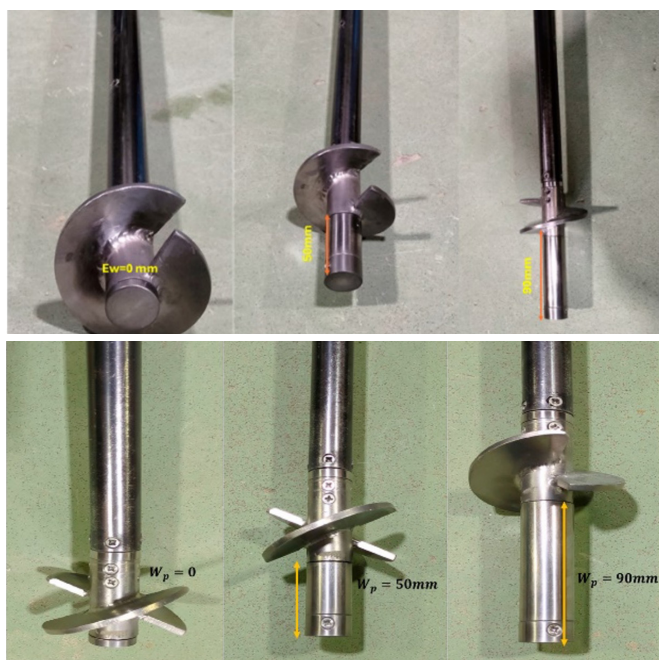

### PERFORMANCE COMPARISON OF TOE-WING AND SPIRAL SCREW PILES

by Ahmad Waheed Sahil, Taro Uchimura, Adnan Anwar Malik, Md Raihanul Kabir

Sustainable and resilient engineering solutions are crucial for current and future infrastructure development to effectively address environmental challenges. In the field of deep foundations, rotary press technology is gaining popularity worldwide for both onshore and offshore applications because of its quick installation, uplift resistance, minimal material waste, lower manpower needs, reduced noise and vibrations, and reusability. This research collaboration between the Newcastle Australia Institute of Higher Education, Singapore, The University of Newcastle Australia, and Saitama University, Japan, focused on comparing the performance of two types of screw piles, namely Spiral (Fig. 1a) and Toe-wing (Fig. b), to facilitate field selection under similar ground conditions.

Fig. 1 Model screw piles used in this research. (a) Spiral screw pile (b) Toe-wing screw pile (Sahil et al., 2025; <https://doi.org/10.3390/buildings15040525>)

# ACADEMIC SEMINAR & EVENTS



JAN  
4-6

## “LEADING SUSTAINABILITY TRANSITIONS: RISK, COLLABORATION, AND TECHNOLOGY” INTERNATIONAL CONFERENCE

Organised in collaboration with the Academy of Global Business Research and Practice (AGBRP), the 18<sup>th</sup> International Conference, titled “Leading Sustainability Transitions: Risk, Collaboration, and Technology,” took place at PSB Academy, boasting a participation of over 100 attendees.

The primary focus of the conference was to explore innovative practices and models in collaboration, leadership, and innovation, with the goal of enhancing business capabilities, resilience, and fostering sustainable outcomes.

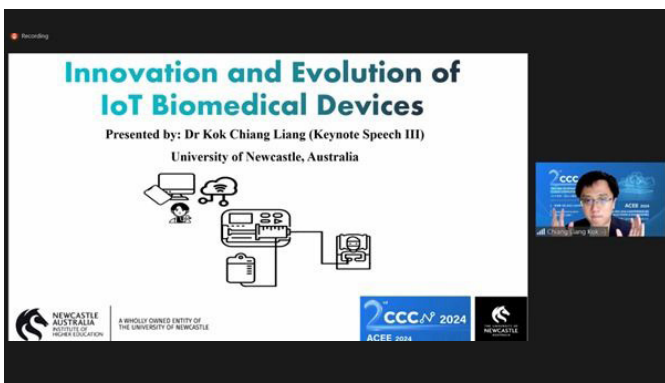

APR  
19-21

## CCCN/ACCE

Newcastle Australia proudly sponsored the 2<sup>nd</sup> International Conference on Cloud Computing and Computer Network (CCCN 2024) and the 2<sup>nd</sup> Asia Conference on Electronics Engineering (ACEE 2024), held virtually from April 19–21. A key highlight was a keynote address by our lecturer, Dr Kok Chiang Liang, who shared insights on the evolving landscape of IoT-based biomedical devices. We are proud to support these dynamic platforms that foster interdisciplinary collaboration and innovation.



APR  
25

## ACADEMIC STRATEGY DAY

Our dedicated team of academic staff gathered at the Bugis Junction Towers campus for an engaging session and dived into discussions relating to academic practices. The day was spiced up with a twist of fun - a hands-on activity where they showcased their creativity and teamwork by building structures with pasta, marshmallows, and string!



MAY  
9

## MENTAL HEALTH AND WELL-BEING IN THE WORKPLACE

We hosted an engaging panel discussion that underscored the importance of fostering supportive workplace cultures and ensuring accessible mental health support. Moderated by Professor Julia Connell, the session featured valuable insights from experts at the University of Newcastle and the Samaritans of Singapore.



**OCT 17** **ACADEMIC STRATEGY DAY**

The Academic team had yet another successful strategy session in October. From strategic planning sessions to engaging workshops, every moment was a step towards a brighter, more inclusive learning environment.



**NOV 8** **ALUMNI & INDUSTRY SYMPOSIUM**

Newcastle Australia hosted an insightful Alumni & Industry Symposium, bringing together thought leaders, industry experts, and alumni for an inspiring day of dialogue focused on the theme "Moving to A More Sustainable Future: Awareness, Action, and Accountability."



The event featured two engaging panel discussions led by industry leaders and thought leaders. The first panel, focused on sustainability practices, provided valuable insights into innovative strategies and practical applications shaping sustainable industries today. We were excited to host distinguished industry speakers, including Genevieve Chua, CEO of Ovul Singapore, Wong Meng Yew, Partner and Leader of Climate and Sustainability (ESG) at Deloitte, and Corinna Choong, Senior Director of Sustainability at the Singapore University of Technology & Design.



**DEC 6** **ENGINEERING POSTER COMPETITION**

The campus was abuzz with excitement as 27 final-year students from the Electrical, Mechanical, and Civil Engineering programs participated in a Poster Competition. The event showcased a range of innovative ideas and high-quality presentations. Congratulations to all participants for their outstanding efforts, with special recognition given to the winners for their exceptional and creative contributions.

# CSD EVENTS



**FEB 29** **HOW CAN SINGAPORE HELP ENERGISE THE TRANSITION TO A CLEANER, GREENER AND MORE SUSTAINABLE FUTURE?**

CSD and the Sustainability Professionals ASEAN Network (SPAN) co-hosted a thought-provoking panel discussion on “How can Singapore Help Energise the Transition to a Cleaner, Greener and More Sustainable Future?”. The event featured a panel of sustainability leaders, including Kavita Gandhi (SEAS), David Fogarty (The Straits Times), Tan Chee Wee (IMC Pan Asia Alliance), and Terence Tan (UN Global Compact Network Singapore), with Ken Hickson moderating the session.



**JUL 4** **IMPROVING LOCAL RESILIENCE TO FLOODS IN THE HUNTER REGION TO ADDRESS SUSTAINABLE DEVELOPMENT GOALS (SDG 13)**

CSD was delighted to invite Associate Professor Ifte Ahmed, the Program Convenor of the postgraduate programs in Disaster Risk and Resilience, University of Newcastle, Australia, to share with us his Highly Commended Inter-disciplinary Research Project: Improving local resilience to floods in the Hunter Region to address Sustainable Development Goal (SDG) 13.

The audience gained an understanding of the floods in eastern Australian specifically in the Hunter region related to climate change. The research focused on how local resilience and adaptive capacity for floods can be improved in local disaster risk management to address SDG 13.1 targets.



**AUG 14-15** **3<sup>RD</sup> ANNUAL ERGONOMICS AND HYGIENE CONFERENCE AND EXHIBITION**

CSD was honoured to be one of the co-organisers and a part of The Annual Ergonomics and Hygiene Conference & Exhibition, hosted by IEH (Institute of Ergonomics and Hygiene) Singapore. The focus of the event was on “From Vision to Action: Uniting Workplace Health with Sustainable Development Goals”.

This unique forum brought together Occupational Hygienists, Ergonomists, and all Health & Safety professionals to network and share best practices. Director of CSD, Dr Charles Lee, along with Co-Founder of Sustainable Gaia, Ms Bhavani Prakash, presented on “Understanding Climate Risks and Opportunities for EHS Professionals,” providing valuable insights into the existential risks of climate change and opportunities available for EHS professionals.



**AUG 15 OPPORTUNITIES IN AGI AND AQUACULTURE MICROBIOME**

In collaboration with the Singapore National Biofilm Consortium, Innovation Partner for Impact Singapore (IPI), and Enterprise Singapore, CSD co-organised an insightful event on 'Opportunities in Agri and Aquaculture Microbiome'. This gathering brought together leading experts to explore the future of sustainable food systems and the critical role of microbiome innovations in agriculture and aquaculture.

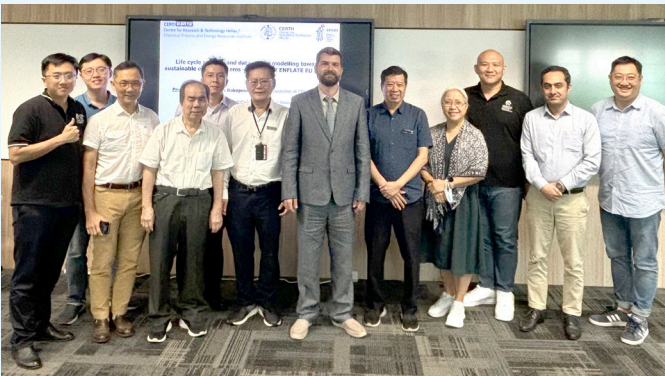

**AUG 27 LIFE CYCLE ANALYSIS AND DATA-DRIVEN MODELLING TOWARDS SUSTAINABLE ENERGY SYSTEMS: THE ENFLATE EU PROJECT**

CSD successfully hosted a sustainable development research seminar in partnership with Engineers Australia. A highlight of the event was the participation of visiting Senior Researcher Dr Dimitrios Rakopoulos from the Centre for Research & Technology Hellas (CERTH)/Chemical Process and Energy Resources Institute, National Technical University of Athens, Greece.



**SEP 12 FORUM ON SUSTAINABILITY AND ITS VALUE: HOW DOES IT IMPACT BUSINESS**

In collaboration with Wong Fong Academy, CSD hosted an insightful forum focusing on the critical importance of sustainability and its impact on Workspace Safety and Health businesses. Dr Charles Lee, Director of CSD, organised a panel session on "Climate-related risks and opportunities for WSH Professionals".



**OCT 4 UN GLOBAL COMPACT NETWORK SINGAPORE APEX AWARDS**

We were proud to be part of the UN Global Compact Network Singapore Apex Awards as the Knowledge Partner for the LowCarbonSG category. Our PVC and CEO, Prof Abhishek, had the honour of presenting the awards to BH Global Corporation, Maxtech Holdings, and Primech A&P. Congratulations to all winners and we look forward to future collaborations with industries on their decarbonisation journey to Net Zero!

# STUDENT LIFE



## JAN 26 BUSINESS CLUB'S "LIMITLESS POSSIBILITIES" SEMINAR

The UON Business Club hosted an engaging seminar featuring distinguished speakers Ms Race Wong, Co-Founder of OhMyHome and proud UON alumna, and Mr Jeremy Cordeiro, EMBA student and Manager at Bentley Systems. The session focused on strategies for ensuring job security and uncovering entrepreneurship opportunities in Singapore's dynamic landscape.



## JAN 27 UNASCS SPORTS DAY 2024

The University of Newcastle, Australia Student Council Singapore (UNASCS) kick-started the new year with an exhilarating Sports Day at the BCA Academy. Over 20 enthusiastic participants, both students and staff alike, came together and participated in this adrenaline-filled event.



## MAR 27 BUSINESS CLUB'S CYBERSECURITY TALK

The Business Club of UON hosted an engaging cybersecurity session featuring Mr Kelvin Wu, a seasoned cybersecurity consultant with over 25 years of experience. Attendees gained valuable insights into tackling today's digital threats, making the event both informative and memorable, with plenty of opportunities for learning and networking.



## APR 3 BUSINESS CLUB'S PICNIC EVENT

Our Business Club students enjoyed a fun-filled evening picnic at Esplanade Park. The event was a great opportunity for students to relax, connect, and build lasting friendships in a vibrant setting.



## MAY 16 STUDENT COUNCIL REUNION

We hosted the Inaugural Student Council Reunion, where past and present members reconnected and forged new bonds. It was a heartwarming event celebrating our community's strong sense of camaraderie. Thank you to all the Student Council members for your dedication over the years. Your commitment has shaped the UON community in Singapore and left a lasting impact.



## AUG 1 BUSINESS CLUB'S "MASTER THE ART OF INFORMATION VERIFICATION AND COMBATING MISINFORMATION" TALK

The UON Business Club proudly hosted an enlightening educational session, "Master the Art of Information Verification and Combating Misinformation". We were honoured to have Mr Mervin Ang, Manager/Librarian (Outreach) from the National Library Board, who empowered our community with essential critical thinking skills for the digital age through his S.U.R.E Talk (Source Understand. Research. Evaluate).



## AUG 2 BUSINESS CLUB

Organised by the UON Business Club, we had an inspiring session with Dr Kevin Cheong, a sessional lecturer with the University. We delved into the power of AI-driven prompts to guide young tourists toward making ethical choices. The insights shared were eye-opening, sparking dynamic discussions on leveraging tech for positive change.



## AUG 6 YAKULT FACTORY TOUR

The UON Business Club organised a trip to the Yakult Singapore Factory, where participants enjoyed a fascinating behind-the-scenes look at the science and innovation behind the production of the popular probiotic drink. From learning about the meticulous manufacturing process to sampling freshly made Yakult, the visit offered an engaging and educational experience.

AUG  
22**WSH TECHNOLOGY – VISION 2028**

Organised by the BEnvOHS Alumni, we had a fantastic turnout at the “WSH Technology – Vision 2028” event. It featured insightful talks from speakers Mufaddal Topiwalla, Vishnu Saran, and Hanzel Lalitan on vehicular safety technology, AI-enabled video analytics, and heat stress management.

OCT  
12**BEYOND LABELS:  
PURPLE PARADE CAMPAIGN**

Newcastle Australia proudly joined Singapore’s largest inclusive movement, the Purple Parade Contingent March, to champion the abilities of Persons with Disabilities. A vibrant team of 80 participants, including staff, students from the Master of Special and Inclusive Education (MSIE) program, members of the Singapore Network for Inclusive Learning (SNIL), and their loved ones, filled the streets of Suntec City with a sea of purple and a spirit of unity. The march was a powerful celebration of inclusion, diversity, and community, reflecting our shared commitment to building a more accepting and empowering society for all.

OCT  
25**STUDENT COUNCIL PARTY**

The University of Newcastle Australia Student Council Singapore (UNASCS) hosted an unforgettable annual student party themed ‘Masquerade’ at the Verandah. With nearly 70 students and staff in attendance, the night was filled with vibrant music from the DJ, delicious food and exciting activities like the ‘Mask Decorating Competition’. The evening wrapped up with a thrilling Lucky Draw, bringing together students from various campuses to relax, connect, and have a blast.

DEC  
3**ART & BLOCKCHAIN FUSION TALK**

The UON Business Club wrapped up the year with a dynamic and inspiring event, “Art & Blockchain Fusion” talk, at our Bugis Junction Tower campus. Attendees enjoyed an evening that blended creativity, innovation, and community spirit, featuring powerful insights from Polly Zhang, an entrepreneur who built a successful art studio in Singapore, and Zihao Lu (Zion), a rising blockchain innovator pushing the frontiers of tech. The event was filled with lively discussions and meaningful connections, making it a memorable close to the year and a celebration of bold ideas and shared inspiration.

# ALUMNI EVENTS



SEP  
26

## ALUMNI EXCELLENCE AWARDS 2024

The Newcastle Australia Alumni Excellence Awards 2024, held in the vibrant Great Hall at the University of Newcastle, brought together around 200 alumni, students, staff and community members to celebrate the outstanding achievements of its global alumni community.

The awards showcased the profound impact of education and the strength of alumni, highlighting inspiring stories that reinforce the University's commitment to excellence and community engagement.



OCT  
3

## ALUMNI MOVIE NIGHT

Held on 3 October, the 13th UON Singapore Alumni Network Movie Night was a resounding success, uniting alumni from 1966 to 2024 for an evening of connection, cuisine, and cinema. Guests mingled in the networking lounge, enjoyed a buffet with wine, and capped off the night with the premiere of *Joker: Folie à Deux*. A true celebration of the UON spirit!



NOV  
8

## SINGAPORE ALUMNI CELEBRATION

On 8 November, we hosted the Singapore Alumni Night 2024 at the Fullerton Hotel, reuniting graduates, students, and staff for an inspiring evening of connection and growth. The event featured an engaging "In Conversation" segment with alumnus Sunny Tan—Asia Director for HSSE & Quality at Cushman & Wakefield—moderated by Pro Vice-Chancellor Professor Abhishek Bhati, spotlighting Sunny's journey of lifelong learning and professional development. The night also marked the first visit of The Hon. Patricia Forsythe AM, the university's 8 Chancellor and alumna, adding special significance to the gathering.



---

A WHOLLY OWNED ENTITY OF  
THE UNIVERSITY OF NEWCASTLE

---

 [newcastleaustralia.edu.sg](http://newcastleaustralia.edu.sg)

